

- NASTRATRICE SEMI-AUTOMATICA A CARTA GOMMATA
- SEMI-AUTOMATIC GUMMED PAPER CASE SEALER
- FERMEUSE DEMI-AUTOMATIQUE POUR BANDE GOMMÉE
- KLEBESTREIFENAUFTRAGS-MASCHINE
- PRECINTADORA SEMIAUTOMATICA PARA PAPEL ENGOMADO

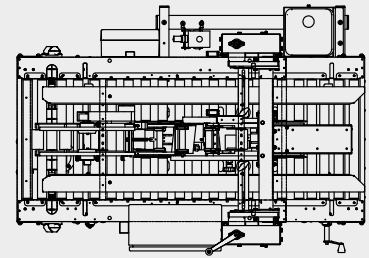

GEM 520-GP

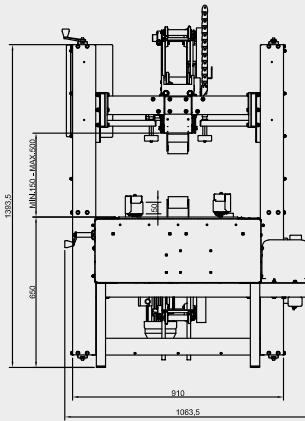
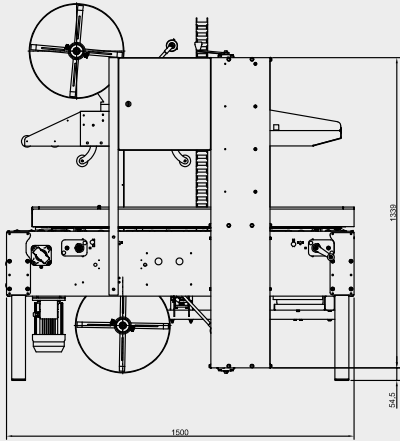
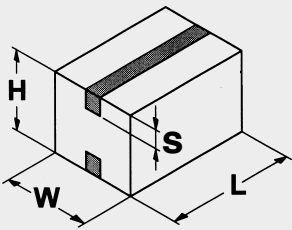

	MIN	MAX
L	150 mm	∞
W	130 * mm	500 mm
H	130 ** mm	500 mm
S	40 mm	80 mm

\* min W 100 mm è possibile per H min 150 mm  
 \*\* min H 100 mm è possibile per W min 200 mm

- Alimentazione pneumatica
- Pneumatic power supply
- Alimentation pneumatique
- Druckluftspeisung
- Alimentación neumática

6 bar

- Consumo aria per ciclo scatola
- Air consumption cycle box
- Consommation d'air par cycle boîtes
- Luftverbrauch pro Kartonzyklus
- Consumo de aire por ciclo caja

0,15 nl



- Alimentazione: 400 V 50-60 Hz
- Power supply: 400 V 50-60 Hz
- Alimentation: 400 V 50-60 Hz
- Speisung: 400 V 50-60 Hz
- Alimentación: 400 V 50-60 Hz

- Potenza installata: 1 kW
- Installed power: 1 kW
- Puissance installée: 1 kW
- Einggerichtete Leistung: 1 kW
- Potencia instalada: 1 kW

- Protezione elettrica: IP54
- Electrical protection: IP54
- Protection électrique: IP54
- Stromschutz: IP54
- Protección eléctrica: IP54

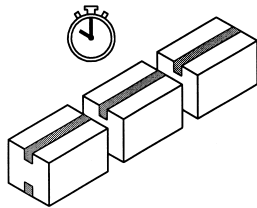

- Produzione media: 420 scatole/ora a colla vegetale  
780 scatole/ora a colla di origine animale
- Average production: 420 box/hour using paper with vegetal origin glue  
780 box/hour using paper with animal origin glue
- Production moyenne: 420 boîtes/heure bande avec colle végétale  
780 boîtes/heure bande avec colle d'origine animale
- Durchschnittliche Produktion: 420 Kartons/Stunde mit Kleber auf pflanzlicher Basis  
780 Kartons/Stunde mit Kleber auf tierischer Basis
- Producción promedio: 420 cajas/hora papel con adhesivo vegetal  
780 cajas/hora con papel con adhesivo de origen animal

- Velocità di trasferimento scatola: ~18 mt/min
- Box transfer speed: ~18 mt/min
- Vitesse de transfert de la boîte: ~18 mt/min
- Transportgeschwindigkeit der Kartons: ~18 mt/min
- Velocidad de desplazamiento caja: ~18 mt/min

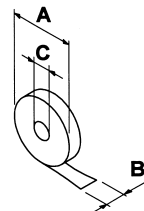

A	MAX 400 mm
B	50 ÷ 80 mm
C	70 mm

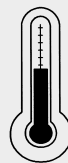

MAX  
+40°C/104°F

MIN  
+5°C/41°F

- Temperatura di utilizzo:
- Temperature of use:
- Température d'utilisation:
- Betriebstemperatur:
- Temperatura de uso:

OPTIONALS

- Lettore fine bobina
- Kit segnalazione rottura nastro
- Indicatore livello acqua
- Segnalatore acustico-visivo
- Contattore scatole
- Esclusione nastratura superiore e/o inferiore

OPTIONALS

- Tape roll end indicator
- Tape application control
- Water level indicator
- Audio - visual alarms
- Boxes counter
- Top & bottom sealing disabling

OPTIONALS

- Lecteur fin de bande
- Kit d'avertissement de rupture de bande
- Indicateur de niveau d'eau
- Signal acoustique et visuel
- Compteur de boîtes
- Exclusion du ruban supérieur et/ou inférieur

OPTIONALS

- Ablesung Spulenende
- Kit Anzeige Bandriss
- Wasserstandanzeige
- Signalanzeige akustisch, optisch
- Kartonzähler
- Ausschluss Verklebung oben und/oder unten

OPTIONALS

- Lector de fin de bobina
- Kit de aviso de rotura de precinto
- Indicador del nivel de agua
- Señales acústicas y visuales
- Contador de cajas
- Exclusión precintado superior y/o inferior

Distributed by

**COMARME**

COMARME S.r.l. a socio unico

sede operativa (factory)  
 Quartiere Mirabella snc, 20081 Abbiategrasso (MI) - ITALY  
 Tel. +39 02 9422002 - Fax +39 02 9422096

e-mail: info@comarmesrl.com - website: www.comarmesrl.com